



J. S. Metalúrgica S.A.

BALCARCE 2930

TEL/FAX: (0341) 4850546 / 4825803

2000 - ROSARIO

e-mail: contacto@jsmetalurgica.com.ar / jsmetalurgicasa@gmail.com / web: www.jsmetalurgica.com.ar

Pcia de SANTA FE - REPÚBLICA ARGENTINA

TERMINALES REUTILIZABLES PARA MANGUERAS SAE 100 R1 Y R2

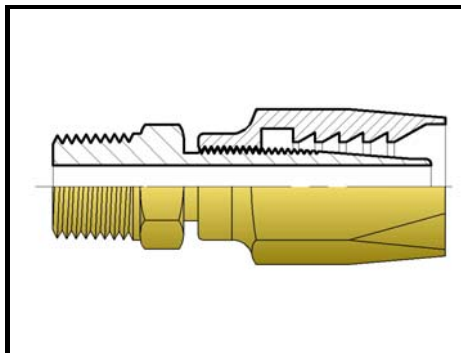
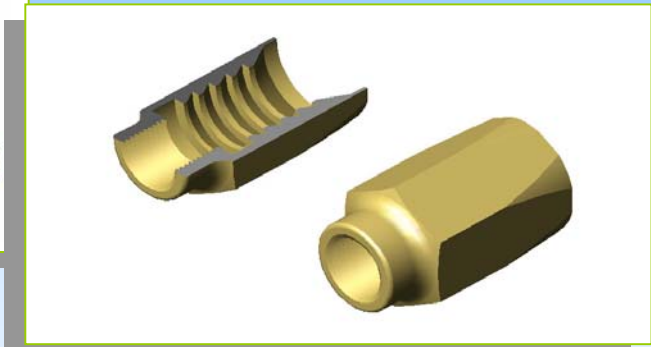
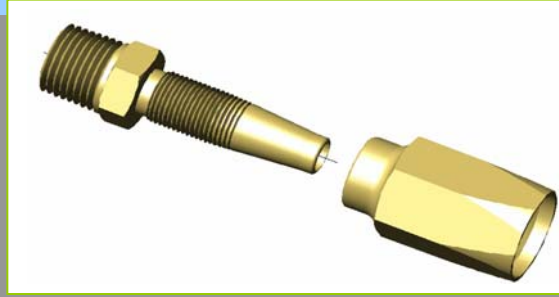

MACHO FIJO - ROSCA NPT

Nº J.S.	Nº J.S.	ROSCA	MANG.	
SAE 100 R1	SAE 100 R2	NPT	Ø INT.	
520-1	520	1/8"	1/4"	
521-1	521	1/4"	1/4"	
522-1	522	3/8"	3/8"	
523-1	523	1/2"	1/2"	
523-A-1	523-A	1/2"	3/8"	
524-1	524	3/4"	3/4"	
525-1	525	1"	1"	
	525-2	1.1/4"	1.1/4"	
	525-3	1.1/2"	1.1/2"	

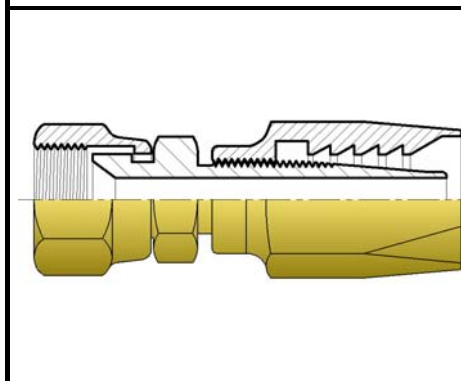

HEMBRA GIRATORIA ROSCA BSP

Nº J.S.	Nº J.S.	ROSCA	MANG.	
SAE 100 R1	SAE 100 R2	BSP	Ø INT.	
530-1	530	1/8"	1/4"	
531-1	531	1/4"	1/4"	
532-1	532	3/8"	3/8"	
533-1	533	1/2"	1/2"	
533-A-1	533-A	1/2"	3/8"	
534-1	534	3/4"	3/4"	
535-1	535	1"	1"	
	535-2	1.1/4"	1.1/4"	
	535-3	1.1/2"	1.1/2"	

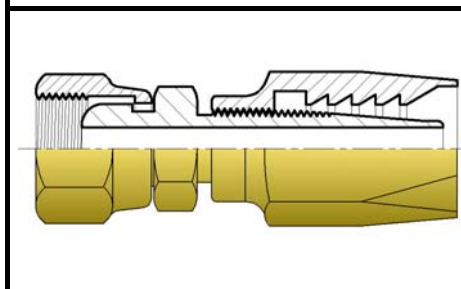

HEMBRA GIRATORIA ASIENTO ESFÉRICO ROSCA BSP

Nº J.S.	Nº J.S.	ROSCA	MANG.	
SAE 100 R1	SAE 100 R2	BSP	Ø INT.	
536-4-4	537-4-4	1/4"	1/4"	
536-6-6	537-6-6	3/8"	3/8"	
536-8-6	537-8-6	1/2"	3/8"	
536-8-8	537-8-8	1/2"	1/2"	
536-12-12	537-12-12	3/4"	3/4"	
536-16-16	537-16-16	1"	1"	



J. S. Metalúrgica S.A.

BALCARCE 2930

TEL/FAX: (0341) 4850546 / 4825803

2000 - ROSARIO

e-mail: contacto@jsmetalurgica.com.ar / jsmetalurgicasa@gmail.com / web: www.jsmetalurgica.com.ar

Pcia de SANTA FE - REPÚBLICA ARGENTINA

		CON UNIÓN ORIENTABLE			
		Nº J.S.	Nº J.S.	Ø INT.	MANG.
	SAE 100 R1	SAE 100 R2	"A"	Ø INT.	
	538-14-4	539-14-4	14	1/4"	
	538-14-6	539-14-6	14	3/8"	
	538-16-6	539-16-6	16	3/8"	
	538-16-8	539-16-8	16	1/2"	
	538-18-6	539-18-6	18	3/8"	
	538-18-8	539-18-8	18	1/2"	
	538-20-6	539-20-6	20	3/8"	
	538-20-8	539-20-8	20	1/2"	
	538-22-6	539-22-6	22	3/8"	
	538-22-8	539-22-8	22	1/2"	

		MACHO FIJO - ROSCA UNF			
		Nº J.S.	Nº J.S.	ROSCA	MANG.
	SAE 100 R1	SAE 100 R2	UNF	Ø INT.	
	539-1	539	7/16"	1/4"	
	540-1	540	1/2"	1/4"	
	541-1	541	9/16"	3/8"	
	541-A-1	541-A	9/16"	1/4"	
	541-2	541-3	3/4"	1/4"	
	542-1	542	3/4"	3/8"	
	543-1	543	3/4"	1/2"	
	544-1	544	7/8"	1/2"	
	544-A-1	544-A	7/8"	3/8"	
	545-1	545	1.1/16"	3/4"	
	545-A-1	545-A	1.3/16"	3/4"	
	546-1	546	1.5/16"	1"	
		546-2	1.5/8"	1.1/4"	
		546-3	1.7/8"	1.1/2"	

		MACHO FIJO- ROSCA UNF- ASIENTO O´RING			
		Nº J.S.	Nº J.S.	ROSCA	MANG.
	SAE 100 R1	SAE 100 R2	UNF	Ø INT.	
	542-A-1	542-A	3/4"	3/8"	
	543-A-1	543-A	3/4"	1/2"	
	543-3	543-4	7/8"	3/8"	
	543-5	543-6	7/8"	1/2"	



J. S. Metalúrgica S.A.

BALCARCE 2930

TEL/FAX: (0341) 4850546 / 4825803

2000 - ROSARIO

e-mail: contacto@jsmetalurgica.com.ar / jsmetalurgicasa@gmail.com / web: www.jsmetalurgica.com.ar

Pcia de SANTA FE - REPÚBLICA ARGENTINA

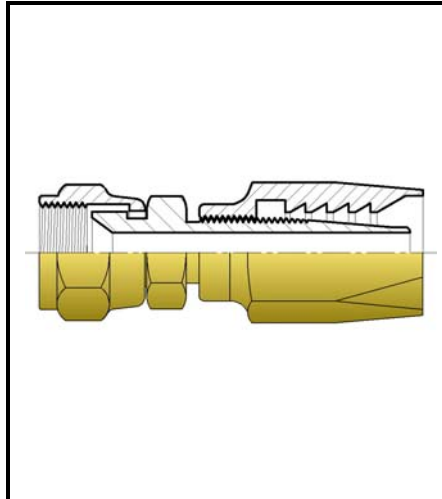

HEMBRA GIRATORIA-ROSCA UNF

Nº J.S.	Nº J.S.	ROSCA	MANG.	
SAE 100 R1	SAE 100 R2	UNF	Ø INT.	
549-1	549	7/16"	1/4"	
550-1	550	1/2"	1/4"	
551-1	551	9/16"	3/8"	
551-A-1	551-A	9/16"	1/4"	
552-1	552	3/4"	3/8"	
553-1	553	3/4"	1/2"	
554-1	554	7/8"	1/2"	
554-A-1	554-A	7/8"	3/8"	
555-1	555	1.1/16"	3/4"	
555-A-1	555-A	1.3/16"	3/4"	
556-1	556	1.5/16"	1"	
	557	1.5/8"	1.1/4"	
	558	1.7/8"	1.1/2"	

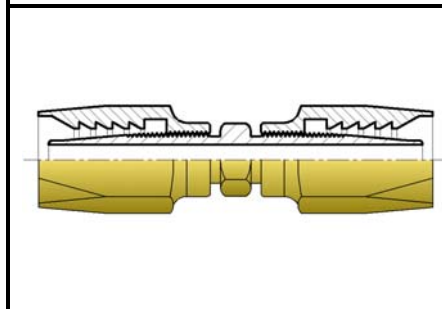

TERMINAL DOBLE

Para unir o prolongar manguera de alta presión de 1 y 2 trenzas de acero

Nº J.S.	Nº J.S.	MANG.	
SAE 100 R1	SAE 100 R2	Ø INT.	
560	565	1/4"	
561	566	3/8"	
562	567	1/2"	
563	568	3/4"	
564	569	1"	

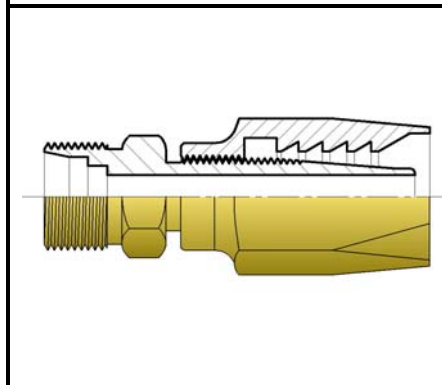

MACHO FIJO PARA VIOLA - ROSCA UNF

Nº J.S.	Nº J.S.	ROSCA	MANG.	
SAE 100 R1	SAE 100 R2	UNF	Ø INT.	
620	621	9/16"	1/4"	
622	623	3/4"	1/4"	
624	625	3/4"	3/8"	
626	627	7/8"	3/8"	
628	629	7/8"	1/2"	
630	631	1.1/16"	3/4"	
630-1	631-1	1.3/16"	3/4"	
632	633	1.5/16"	1"	

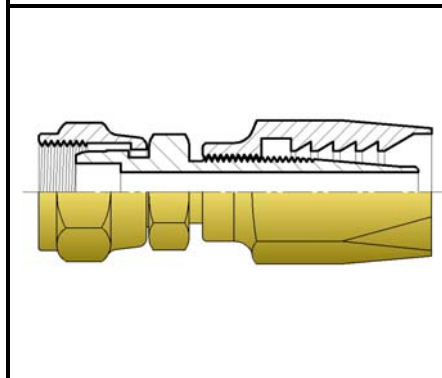

HEMBRA GIRATORIA - CIERRE ERMETO (VIOLA)

Nº J.S.	Nº J.S.	ROSCA	MANG.	
SAE 100 R1	SAE 100 R2	UNF	Ø INT.	
640	641	9/16"	1/4"	
642	643	3/4"	1/4"	
644	645	3/4"	3/8"	
646	647	7/8"	3/8"	
648	649	7/8"	1/2"	
650	651	1.1/16"	3/4"	
650-1	651-1	1.3/16"	3/4"	
652	653	1.5/16"	1"	



J. S. Metalúrgica S.A.

BALCARCE 2930

TEL/FAX: (0341) 4850546 / 4825803

2000 - ROSARIO

e-mail: contacto@jsmetalurgica.com.ar / jsmetalurgicasa@gmail.com / web: www.jsmetalurgica.com.ar

Pcia de SANTA FE - REPÚBLICA ARGENTINA

ACOPLES RÁPIDOS SERVICIO HIDRÁULICO

N° J.S.	DESCRIPCIÓN		
660	CUERPO ROSCA 1/2" NPT		Con Bolilla
661	CUERPO ROSCA 3/4" NF		
660-2-P	CUERPO ROSCA 1/4" NPT		Con Punta
660-P	CUERPO ROSCA 1/2" NPT		
661-P	CUERPO ROSCA 3/4" NF		
662	NIPLE ROSCA 1/2" NPT		Con Bolilla
663	NIPLE ROSCA 3/4" NF		
662-2-P	NIPLE ROSCA 1/4" NPT		Con Punta
662-P	NIPLE ROSCA 1/2" NPT		
663-P	NIPLE ROSCA 3/4" NF		
664-2	TAPÓN MACHO 1/4"		
664	TAPÓN MACHO 1/2"		
665-2	TAPÓN HEMBRA 1/4"		
665	TAPÓN HEMBRA 1/2"		



J. S. Metalúrgica S.A.

BALCARCE 2930



TEL/FAX: (0341) 4850546 / 4825803

2000 - ROSARIO

e-mail: contacto@jsmetalurgica.com.ar / jsmetalurgicasa@gmail.com / web: www.jsmetalurgica.com.ar

Pcia de SANTA FE - REPÚBLICA ARGENTINA

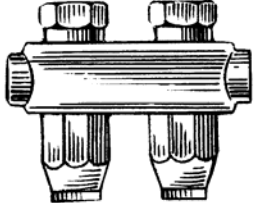
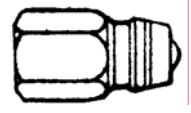
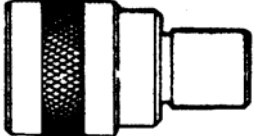
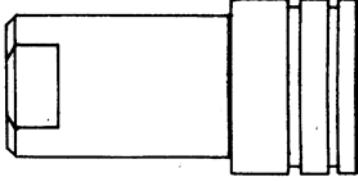
ACOPLES RÁPIDOS SERVICIO HIDRÁULICO

N° J.S.	DESCRIPCIÓN	PRECIO
666	SOPORTE DUPLEX PARA COLOCAR	
667	NIPLE ROSCA 1/2" NPT (J. DEERE)	
668	NIPLE ROSCA 1/2" NPT (J. DEERE)	
669	ROSCA 3/4" UNF (J. DEERE)	
669-1	CUERPO ROSCA 1/2" NPT (ZANELLO)	
669-2	CUERPO ROSCA 1/2" NPT (DEUYZ)	
669-3	CUERPO ROSCA 22 x 1.1/2" (FIAT)	

SOPORTE DOBLE PARA CAÑERÍA HIDRÁULICA

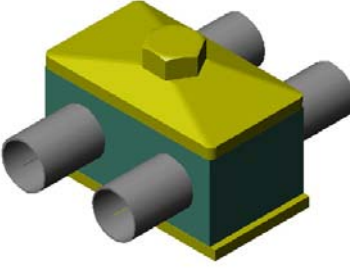
	P/ TUBO	
669-10	3/8"	
669-11	1/2"	
669-12	5/8"	



J. S. Metalúrgica S.A.

BALCARCE 2930

TEL/FAX: (0341) 4850546 / 4825803

2000 - ROSARIO

e-mail: contacto@jsmetalurgica.com.ar / jsmetalurgicasa@gmail.com / web: www.jsmetalurgica.com.ar

Pcia de SANTA FE - REPÚBLICA ARGENTINA

TUERCAS PARA CIERRE CON VIOLA

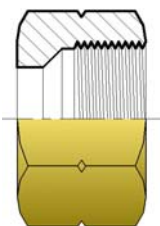
	P/ CIERRE CON VIOLA SAE				P/ CIERRE CON VIOLA DIN (milimétricas)			
	Nº J.S.	ROSCA UNF	TUBO Ø EXT.		Nº J.S.	ROSCA DIN	TUBO Ø EXT.	
	670	1/2"	5/16"		685	14 x 1.1/2"	6	
	671	9/16"	3/8"		686	16 x 1.1/2"	8	
	672	3/4"	1/2"		687	18 x 1.1/2"	10	
	673	7/8"	5/8"		688	20 x 1.1/2"	12	
	674	1.1/16"	3/4"		689	22 x 1.1/2"	14	
	675	1.3/16"	7/8"		690	24 x 1.1/2"	16	
	676	1.5/16"	1"		691-30	30 x 2"	20	
					692-36	36 x 2"	25	
					693-42	42 x 2"	30	
					694-52	52 x 2"	38	

VIOLAS

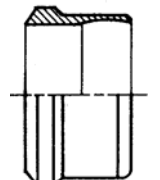
	P/ CIERRE CON VIOLA SAE			P/ CIERRE CON VIOLA DIN (milimétricas)		
	Nº J.S.	TUBO Ø EXT.		Nº J.S.	TUBO Ø EXT.	
	677	5/16"		695	6	
	678	3/8"		696	8	
	679	1/2"		697	10	
	680	5/8"		698	12	
	681	3/4"		699	14	
	682	7/8"		699-1	15	
	683	1"		700	16	
				700-18	18	
				700-20	20	
				700-22	22	
				700-24	24	
				700-25	25	
				700-28	28	
				700-30	30	
				700-35	35	
				700-38	38	